

**Alvaline**

**For m**

**istruzioni di montaggio  
installing instructions  
Gebrauchsanweisung  
instructions de montage  
instrucciones de montaje**

**sistema 094 europa-usa**

**Viabizzuno**

**progettiamo la luce**

- IT AVVERTENZE:** All'atto dell'installazione, ed ogni volta che si interviene sulla lampada, assicurarsi che sia stata tolta la tensione di alimentazione. Le operazioni di installazione e collegamento alla rete elettrica devono essere effettuate esclusivamente da personale qualificato.
- GB WARNING:** When installing fixture and during unkeep take care that the mains voltage is switched off. The operations of installation and connection to power mains should be done by skilled personnel only.
- DE HINWEISE:** Während der Installation und bei allen nachfolgenden Arbeiten auf der Lampe sollte sichergestellt werden, daß die Versorgungsspannung vorher abgenommen wurde. Die Arbeiten zur Installation und zum Anschluss an das Stromnetz sind von Fachpersonal durchzuführen.
- FR AVERTISSEMENTS:** Lors de l'installation et à chaque fois que l'on fait un entretien sur la lampe, s'assurer que la tension d'alimentation ait été coupée. Les opérations d'installation et de branchement au réseau électrique doivent être effectuées par un personnel qualifié.
- ES ADVERTENCIA:** Durante la instalación, y cada ve que se interviene sobre la lámpara, asegurarse que la alimentación haya sido desconectada. Las operaciones de instalación y conexión a la red eléctrica tienen que ser efectuadas exclusivamente por personal cualificado.

**IT ATTENZIONE:**

La sicurezza dell'apparecchio è garantita solo rispettando queste istruzioni sia in fase di installazione che di impiego.

**GB WARNING:**

Fitting safety is only guaranteed if the following instructions are strictly observed both during installation and use.

**DE ACHTUNG:**

Für die Sicherheit des Geräts kann nur dann die Garantie übernommen werden, wenn die in den vorliegenden Anweisungen enthaltenen Hinweise sowohl bei der Installation als auch beim Betrieb beachtet werden.

**FR ATTENTION:**

La sécurité de l'appareil n'est assurée que lorsque les consignes portées sont respectées, tant lors de l'installation que durant l'utilisation de l'appareil.

**ES ATENCIÓN:**





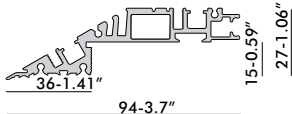

La seguridad del aparato está garantizada sólo si se respetan estas instrucciones durante la fase de instalación y de empleo.

- IT** garanzia  
**GB** warranty  
**DE** garantie  
**FR** garantie  
**ES** garantía

- IT** La presente garanzia è valida 24 mesi se timbrata e datata dal rivenditore autorizzato Viabizzuno. Il periodo di garanzia è di 2 anni a partire dalla data della timbratura e decade in caso di uso improprio, manomissione o cancellatura della data, perdita o illeggibilità del presente libretto di istruzioni.
- GB** The warranty covers 24 months if stamped and dated by the authorised Viabizzuno dealer. The 24 months warranty shall not apply in case of wrong use, altered or deleted date, or if this instructions booklet gets lost or becomes unreadable.
- DE** Die Garantie gilt 24 Monate nur, wenn sie von dem zugelassenen Verkäufer Viabizzuno gestempelt wird. Die Garantie gilt 2 Jahr seit dem Stempeldatum und verfällt bei unberechtigten Gebrauch, Manipulation des Datums, Verlust oder Unlesbarkeit von den Gebrauchsanweisungen.
- FR** La durée de la garantie est de 24 mois si elle est marquée par le distributeur autorisé Viabizzuno. La garantie est valable 2 ans depuis le jour où elle a été marquée et échoit en cas d'usage impropre, alteration ou effacement de la date, e si le carnet d'instructions est perdu ou est indéchiffrable.
- ES** Esta garantía es válida por 24 meses sólo si está datada y sellada por el revendedor autorizado Viabizzuno. El período de garantía es de 2 años a partir de la fecha del sello, y decae en caso de empleo impropio, alteración o borrado de la fecha, pérdida o ilegibilidad del presente manual de instrucciones



**h 15mm-0.59"** ©

|              |    |  |  |        |       |
|--------------|----|--|--|--------|-------|
| 500-19.68"   | 2x |    | <b>*F6.094.02</b> coppia<br>pair<br>Paar<br>paire<br>par   | 500mm  | 1,3kg |
| 1000-39.37"  | 2x |    | <b>*F6.094.04</b> coppia<br>pair<br>Paar<br>paire<br>par   | 1000mm | 2,5kg |
| 2000-78.74"  | 2x |    | <b>*F6.094.06</b> coppia<br>pair<br>Paar<br>paire<br>par   | 2000mm | 5,0kg |
| 3000-118.11" | 2x |    | <b>*F6.094.08</b> coppia<br>pair<br>Paar<br>paire<br>par   | 3000mm | 7,6kg |
|              |    |  | <b>**F6.094.09</b> pallet 100pz  | 3000mm |       |
| 70-2.75"     |    |   | <b>F6.094.22</b> coppia testata 70<br>pair of ends 70<br>Paar Endstücke 70<br>paire de finition 70<br>Pareja cabezal 70      |        | 0,8kg |
| 140-5.51"    |    |  | <b>F6.094.24</b> coppia testata 140<br>pair of ends 140<br>Paar Endstücke 140<br>paire de finition 140<br>Pareja cabezal 140 |        | 0,9kg |

**h 15mm-0.59"**

€

500-19.68"



**\*F6.094.02.N** coppia anodizzato nero 500mm 1,3kg  
 pair of black anodised  
 Schwarz eloxiertes Paar  
 paire anodisé noir  
 par anodizado negro

1000-39.37"



**\*F6.094.04.N** coppia anodizzato nero 1000mm 2,5kg  
 pair of black anodised  
 Schwarz eloxiertes Paar  
 paire anodisé noir  
 par anodizado negro

2000-78.74"



**\*F6.094.06.N** coppia anodizzato nero 2000mm 5,0kg  
 pair of black anodised  
 Schwarz eloxiertes Paar  
 paire anodisé noir  
 par anodizado negro

3000-118.11"



**2x\*F6.094.08.N** coppia anodizzato nero 3000mm 7,6kg  
 pair of black anodised  
 Schwarz eloxiertes Paar  
 paire anodisé noir  
 par anodizado negro

**\*\*F6.094.09.N** pallet anodizzato nero 100pz 3000mm  
 pallet black anodised  
 pallet Schwarz eloxiertes  
 pallet anodisé noir  
 pallet anodizado negro

70-2.75"



**F6.094.22.N** coppia testata 70 0,8kg  
 pair of ends 70  
 Paar Endstücke 70  
 paire de finition 70  
 Pareja cabezal 70

140-5.51"



**F6.094.24.N** coppia testata 140 0,9kg  
 pair of ends 140  
 Paar Endstücke 140  
 paire de finition 140  
 Pareja cabezal 140

\* completi di giunti di congiunzione / are completely with joints / inkl. Verbindungsstücke / avec joints de raccord / completos de uniones de unión.

\*\* i giunti lineari non sono forniti, quindi bisogna acquistarli separatamente / the linear joints are not included and should be ordered separately / die linearen Verbindungsstücke werden nicht mitgeliefert, sie müssen daher separat angeschafft werden / les joints linéaires ne sont pas fournis, les commander séparément / las uniones lineales no se suministran, por lo tanto es necesario comprarlas a parte



**F6.094.42** raccordo angolare interno singolo 0,1kg  
internal corner join einzelne  
Eckanschlüsse innen  
un angle intérieur  
individual conexión angular interior

**F6.094.42.N** raccordo angolare interno singolo 0,1kg  
anodizzato nero  
internal corner join einzelne  
black anodised  
Eckanschlüsse innen Schwarz eloxiertes  
un angle intérieur anodisé noir  
individual conexión angular interior  
anodizado negro



**F6.094.44** raccordo angolare esterno singolo 0,1kg  
external corner join einzelne  
Eckanschlüsse außen un angle extérieur  
Individual conexiones angulares exteriores

**F6.094.44.N** raccordo angolare esterno singolo 0,1kg  
anodizzato nero  
external corner join einzelne  
black anodised  
Eckanschlüsse außen un angle extérieur  
Schwarz eloxiertes  
raccord d'angle externe simple Individual  
anodisé noir  
conexiones angulares exteriores  
anodizado negro

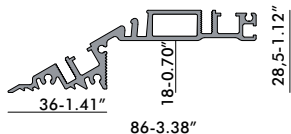

**h 18mm-0.70"**

☰

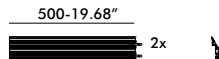

**\*F6.094.02.U** coppia  
pair  
Paar  
paire  
par  
19.68" 1,3kg

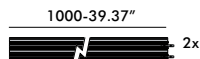

**\*F6.094.04.U** coppia  
pair  
Paar  
paire  
par  
39.37" 2,5kg

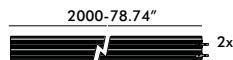

**\*F6.094.06.U** coppia  
pair  
Paar  
paire  
par  
78.74" 5,0kg

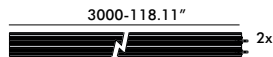

**\*F6.094.08.U** coppia  
pair  
Paar  
paire  
par  
118.11" 7,6kg

**\*\*F6.094.09.U** pallet 100pz

118.11"

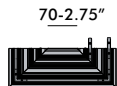

**F6.094.22.U** coppia testata 70  
pair of ends 70  
Paar Endstücke 70  
paire de finition 70  
Pareja cabezal 70  
0,8kg



**F6.094.24.U** coppia testata 140  
pair of ends 140  
Paar Endstücke 140  
paire de finition 140  
Pareja cabezal 140  
0,9kg

**h 18mm-0.70"**

€

500-19.68"



**\*F6.094.02.N.U** coppia anodizzato nero 19.68" 1,3kg  
 pair of black anodised  
 Schwarz eloxiertes Paar  
 paire anodisé noir  
 par anodizado negro

1000-39.37"



**\*F6.094.04.N.U** coppia anodizzato nero 39.37" 2,5kg  
 pair of black anodised  
 Schwarz eloxiertes Paar  
 paire anodisé noir  
 par anodizado negro

2000-78.74"



**\*F6.094.06.N.U** coppia anodizzato nero 78.74" 5,0kg  
 pair of black anodised  
 Schwarz eloxiertes Paar  
 paire anodisé noir  
 par anodizado negro

3000-118.11"



**2x\*F6.094.08.N.U** coppia anodizzato nero 118.11" 7,6kg  
 pair of black anodised  
 Schwarz eloxiertes Paar  
 paire anodisé noir  
 par anodizado negro

**\*\*F6.094.09.N.U** pallet anodizzato nero 100pz 118.11"  
 pallet black anodised  
 pallet Schwarz eloxiertes  
 pallet anodisé noir  
 pallet anodizado negro

70-2.75"



**F6.094.22.N.U** coppia testata 70 0,8kg  
 pair of ends 70  
 Paar Endstücke 70  
 paire de finition 70  
 Pareja cabezal 70

140-5.51"



**F6.094.24.N.U** coppia testata 140 0,9kg  
 pair of ends 140  
 Paar Endstücke 140  
 paire de finition 140  
 Pareja cabezal 140



\* completi di giunti di congiunzione / are completely with joints / inkl. Verbindungsstücke / avec joints de raccord / completos de uniones de unión.

\*\* i giunti lineari non sono forniti, quindi bisogna acquistarli separatamente / the linear joints are not included and should be ordered separately / die linearen Verbindungsstücke werden nicht mitgeliefert, sie müssen daher separat angeschafft werden / les joints linéaires ne sont pas fournis, les commander séparément / las uniones lineales no se suministran, por lo tanto es necesario comprarlas a parte



**F6.094.42.U** raccordo angolare interno singolo 0,1kg  
internal corner join einzelne  
Eckanschlüsse innen  
un angle intérieur  
individual conexión angular interior

**F6.094.42.N.U** raccordo angolare interno singolo 0,1kg  
anodizzato nero  
internal corner join einzelne  
black anodised  
Eckanschlüsse innen Schwarz eloxiertes  
un angle intérieur anodisé noir  
individual conexión angular interior  
anodizado negro



**F6.094.44.U** raccordo angolare esterno singolo 0,1kg  
external corner join einzelne  
Eckanschlüsse außen un angle extérieur  
Individual conexiones angulares exteriores

**F6.094.44.N.U** raccordo angolare esterno singolo 0,1kg  
anodizzato nero  
external corner join einzelne  
black anodised  
Eckanschlüsse außen un angle extérieur  
Schwarz eloxiertes  
raccord d'angle externe simple Individual  
anodisé noir  
conexiones angulares exteriores  
anodizado negro

**componenti**

€

- F6.094.45** raccordo angolare verticale/orizzontale H15 0,07kg  
vertical / horizontal elbow fitting  
Eckanschluss senkrecht/waagrecht  
raccord d'angle vertical/horizontal  
conexión angular vertical/horizontal
- F6.094.45.U** raccordo angolare verticale/orizzontale H18  
vertical / horizontal elbow fitting  
Eckanschluss senkrecht/waagrecht  
raccord d'angle vertical/horizontal  
conexión angular vertical/horizontal



- F6.094.46** coppia giunto lineare 0,02kg  
pair of linear joints  
1 Paar lineare Verbindungsstücke  
paire de jonctions linéaires  
pareja unión lineal

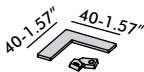

- F6.094.48** coppia giunto angolare 0,02 kg  
pair of angular joints  
1 Paar Eckverbindungen  
paire de jonctions angulaires  
pareja unión angular

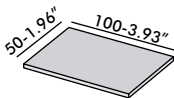

- F6.094.50** spessore 2mm (20pz) 0,1 kg  
thickness 2mm (20pz)  
Dicke 2mm (20pz)  
épaisseur 2mm (20pz)  
distanciador 2mm (20pz)

**IT Note:**  
**GB Notes:**  
**DE Hinweise:**  
**FR Notes:**  
**ES Notas:**

- IT** A seconda della larghezza desiderata del taglio (X), distanziare il cartongesso di una distanza pari a  $X+72\text{mm}$  (usa- $X+2,82''$ )
- GB** Space out the plasterboard at a distance of  $X+72\text{mm}$  (usa- $X+2,82''$ ), depending on the width of the cut (X) required
- DE** Je nach der gewünschten Länge des Schnitts (X) den Gipskarton in einem Abstand von  $X+72\text{mm}$  (usa- $X+2,82''$ ) anbringen.
- FR** Selon la largeur souhaitée de la coupe (X), placer le placoplâtre à une distance égale à  $X+72\text{mm}$  (usa- $X+2,82''$ ).
- ES** Según la anchura deseada del corte (X), alejar el cartón de yeso de una distancia igual a  $X+72\text{mm}$  (usa- $X+2,82''$ ).

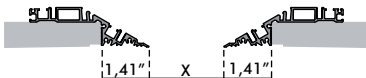
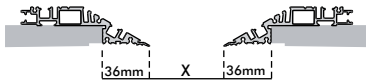

- IT** Montare le lastre di cartongesso con lo scasso (A) in corrispondenza del profilo (vedi fig.) per evitare che al momento della stuccatura si generino irregolarità.
- GB** Fit the tapered edge of plasterboard (A) to the edge of the profile (see fig), in order to avoid a rough surface when filled.
- DE** Die Gipskarton-Platten so montieren, dass sich der Hohlraum in Übereinstimmung mit dem Profil (siehe Abb.) befindet, um zu vermeiden, dass beim Verspachteln Unregelmäßigkeiten auftreten.
- FR** Monter les plaques de placoplâtre avec la rainure (A) au niveau du profil (voir fig.) pour éviter l'apparition d'irrégularités au moment de la finition.
- ES** Montar las placas de cartón de yeso con el hueco (A) en correspondencia del perfil (véase fig. ) para evitar que en el momento de enmasillar se generen irregularidades.

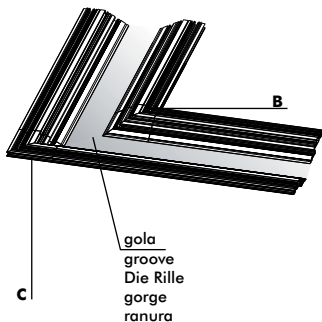

- IT** Con gli articoli **F6.094.42-F6.094.42.U** (raccordo angolare interno) e **F6.094.44-F6.094.44.U** (raccordo angolare esterno) è possibile realizzare angoli interni (B) e angoli esterni (C).
- GB** With articles **F6.094.42-F6.094.42.U** (internal corner joint) and **F6.094.44-F6.094.44.U** (external corner joint) it is possible to create both internal (B) and external (C) corners .
- DE** Mit Artikel **F6.094.42-F6.094.42.U** (Eckanschluss innen) und **F6.094.44-F6.094.44.U** (Eckanschluss außen) ist es möglich, Innenecken (B) und Außenecken (C) herzustellen.
- FR** Avec les articles **F6.094.42-F6.094.42.U** (un angle intérieur) et **F6.094.44-F6.094.44.U** ( un angle extérieur) il est possible de réaliser des angles internes (B) et des angles externes (C).
- ES** Con los artículos **F6.094.42-F6.094.42.U** (conexión angular interior) y **F6.094.44-F6.094.44.U** (conexión angular exterior) es posible realizar ángulos interiores (B) y ángulos exteriores (C).

1. **IT** Realizzare un foro nel cartongesso delle dimensioni desiderate, a seconda dei componenti che si intendono utilizzare.
- GB** Cut a hole in the plasterboard to take the size of profile required
- DE** Eine Öffnung in der Größe gemäß der einzusetzenden Bauteile in den Gipskarton schneiden.
- FR** Réaliser dans le placoplâtre un trou aux dimen
- ES** Realizar un orificio en el cartón yeso del tamaño deseado, según los componentes que se quieren utilizar.

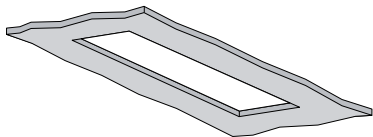

2. **IT** Assemblare la cornice unendo le testate (B) e i profili (C) delle dimensioni desiderate attraverso i giunti (A). Serrare i grani (D) per assicurarne l'unione.
- GB** Fit the frame by connecting the ends (B) to the profiles (C) by means of the connectors (A). To fix the parts together, tighten the machine screws (D).
- DE** Die Endstücke (B) und die Profile (C) mithilfe der Verbindungsstücke (A) zu einem Rahmen in der gewünschten Größe montieren. Die Stifte (D) anziehen, um den Zusammenhalt sicher zu stellen
- FR** Assembler le cadre en unissant les têtes (B) et les profils (C) aux dimensions souhaitées à l'aide des joints (A). Serrer les goujons (D) pour garantir l'assemblage.
- ES** Ensamblar el marco uniendo los cabezales (B) y los perfiles (C) de los tamaños deseados mediante las uniones (A). Apretar los pasadores (D) para asegurar la unión.

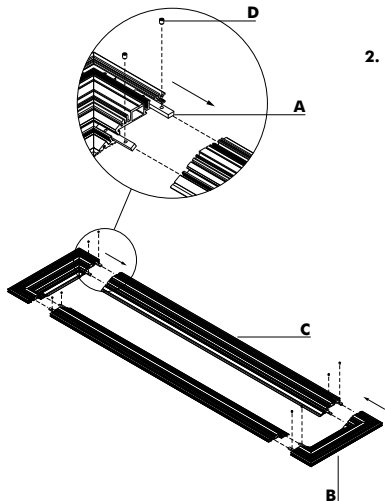

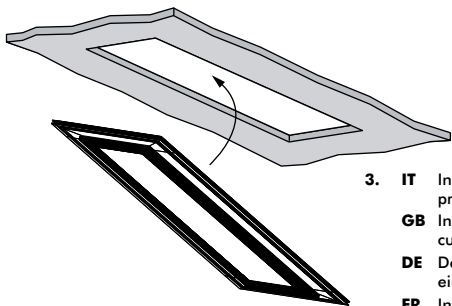

- 3. IT** Inserire la cornice assemblata nel foro praticato.
- GB** Insert the assembled frame into the hole cut in the plasterboard.
- DE** Den montierten Rahmen in die Öffnung einsetzen.
- FR** Introduire le cadre assemblé dans le trou pratiqué.
- ES** Introducir el marco ensamblado en el orificio realizado.

- 4. IT** Fissare al controsoffitto la cornice attraverso viti autofilettanti facendo attenzione che le stesse rimangano all'interno della camera (X). Se viene utilizzato un cartongesso inferiore a 15mm (europa)-18mm-0,70" (usa), spessorare adeguatamente in modo che la punta estrema (E) della cornice sia sullo stesso livello del cartongesso.

- GB** Fasten the frame to the false ceiling by means of using self-tapping screws, ensuring the screws are always contained within the enclosed channel (X). If plasterboard whose thickness is less than 15 mm (europa)-18mm-0,70" (usa) is used, adequately increase its thickness, so that the outer tip (E) of the frame is on the same plasterboard surface.

- DE** Den Rahmen mithilfe selbstschneidender Schrauben an der Hängedecke befestigen und darauf achten, dass die Schrauben innerhalb des Innenraums (X) bleiben. Falls ein Gipskarton mit Stärke unter 15 mm (europa)-18mm-0,70" (usa) eingesetzt wird, ist dieser ausreichend zu unterlegen, so dass die äußere Spitze (E) des Rahmens auf einer Ebene mit dem Gipskarton liegt.

- FR** Fixer au faux plafond le cadre avec les vis autotaraudeuses en veillant à ce qu'elles restent à l'intérieur de la chambre (X). Si l'on utilise un placoplâtre inférieur à 15mm (europa)-18mm-0,70" (usa), caler de manière à ce que la pointe extrême (E) du cadre soit au même niveau que le placoplâtre.

- ES** Fijar al contratecho el marco mediante tornillos autorroscantes, cuidando que los mismos queden en el interior de la cámara (X). Si se utiliza un cartón yeso con espesor inferior a 15mm (europa)-18mm-0,70" (usa), poner un elemento de espesor adecuado de modo que la punta extrema (E) del marco esté a ras con el nivel del cartón yeso

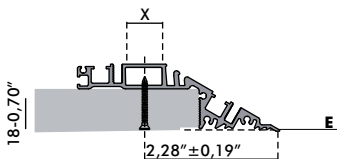
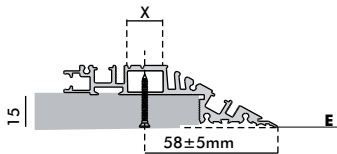

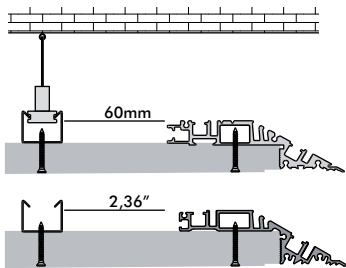

- IT IMPORTANTE:** quando si costruisce la struttura metallica del controsoffitto, posizionare un montante a 60mm (2,36") dalla fine del profilo 094. (vedi fig.)
- GB IMPORTANT:** when erecting the metal framework for the suspended ceiling, fit an upright 60mm (2,36") from the end of the profile frame 094 (see diagram)
- DE ACHTUNG:** Die Halterung bei der Herstellung der Metallstruktur an der Hängedecke bei einer Distanz von 60mm (2,36") zum äußeren Ende des Profils 094 positionieren (siehe Abb.).
- FR IMPORTANT:** lors de la réalisation de la structure métallique du faux plafond, placer un montant à 60mm (2,36") de l'extrémité du profil 094 (voir fig.)
- ES IMPORTANTE:** al construir la estructura metálica del cielo raso, colocar un montante a 60mm (2,36") del extremo del perfil 094 (ver fig).



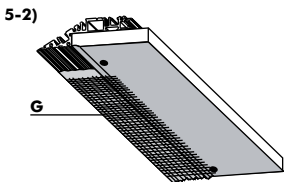
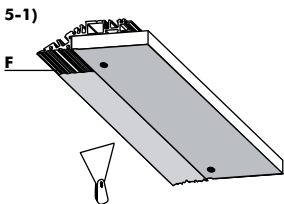

- 5. IT** 5-1) Stuccare la superficie (F) del profilo in modo da otturare tutte le scanalature.  
5-2) Applicare l'apposita garza (G) nella zona di congiunzione tra cartongesso e alluminio.
- GB** 5-1) Fill the surface (F) of the profile. Ensure all the grooves are filled.  
5-2) Apply the gauze (G) in the area between the plasterboard and aluminium.
- DE** 5-1) Die Oberfläche des Profils (F) so verspachteln, dass alle Rillen bzw. Unebenheiten ausgeglichen werden.  
5-2) Die Gaze (G) an der Verbindungsfläche zwischen Gipskarton und Aluminium platzieren.
- FR** 5-1) Stiquer la surface (F) du profil de manière à boucher toutes les rainures.  
5-2) Appliquer la fibre (G) dans la zone de raccord entre placoplâtre et aluminium.
- ES** 5-1) Enmasillar la superficie (F) del perfil de modo de obturar todas las ranuras.  
5-2) Aplicar la gasa suministrada (G) en la zona de unión entre cartón yeso y aluminio.

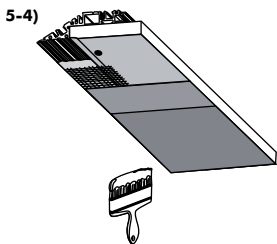
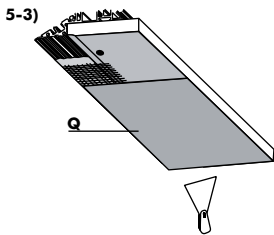

- 5. IT** 5-3) Stuccare nuovamente in modo da ottenere una superficie (Q) regolare.  
5-4) Rasare e riverniciare.  
**ATTENZIONE:** alla fine dell'operazione deve risultare una superficie unica e uniforme con il cartongesso.
- GB** 5-3) Putty again thus obtaining a smooth surface (Q).  
5-4) Smooth and paint again.  
**ATTENTION:** at the end of the process one surface only on the same level of the plasterboard should be obtained.
- DE** 5-3) Nochmals verspachteln, um eine gleichmäßige Oberfläche (Q) zu erhalten.  
5-4) Abschaben und überstreichen.  
**ACHTUNG:** Das Endergebnis sollte eine einheitliche, gleichmäßige Oberfläche mit dem Gipskarton bilden
- FR** 5-3) Stiquer de nouveau de manière à obtenir une surface (Q) régulière.  
5-4) Raser et peindre de nouveau.  
**ATTENTION:** à la fin de l'opération la surface doit être lisse et uniforme avec le placoplâtre.
- ES** 5-3) Volver a enmasillar de nuevo de modo de conseguir una superficie (Q) regular.  
5-4) Pulir y volver a pintar.  
**ATENCIÓN:** al final de la operación tiene que conseguirse una superficie única y uniforme con el cartón yeso.

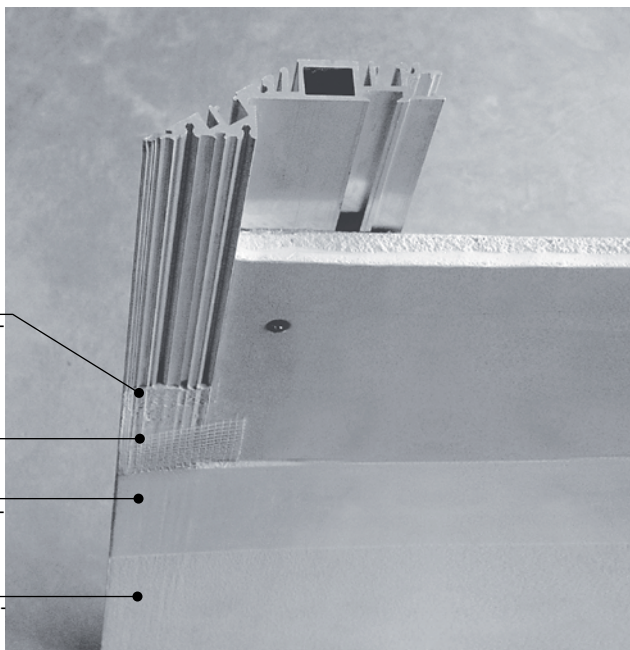

stucco-plaste-  
Spachtelmasse-  
stuc-masilla

garza-gauze-  
Gaze-maille-  
gasa

stucco-plaste-  
Spachtelmasse-  
stuc-masilla

vernice-paint-  
Farbe-peinture-  
pintura

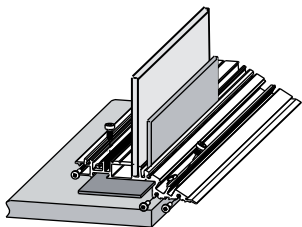

### utilizzo gole profilo 094

6-1)

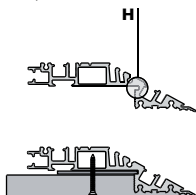

- 6.1 IT** 6-1 Nella scanalatura (H) è possibile inserire un distanziatore nel caso in cui si utilizzi un cartongesso di spessore inferiore a 15mm.
- GB** 6-1 A spacer may be inserted in the groove (H) in case that the plasterboard thickness is less than 15mm.
- DE** 6-1 In di Nut (H) kann ein Abstandhalter eingesetzt werden, falls Gipskarton mit einer Stärke unter 15 mm verwendet wird.
- FR** 6-1 Dans la rainure (H) il est possible d'introduire une entretoise si l'on utilise un placoplâtre d'une épaisseur inférieure à 15 mm.
- ES** 6-1 En la ranura (H) es posible introducir un distanciador en el caso de que se emplee un cartón yeso con diámetro inferior a 15 mm.

6-2)

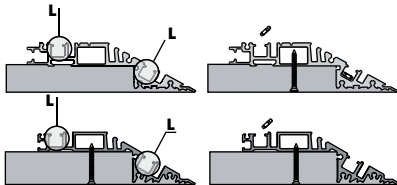

- 6.2 IT** 6-2 Nelle gole (L) è possibile inserire dadi M4.
- GB** 6-2 M4 nuts may be inserted in the grooves (L).
- DE** 6-2 In die Gewinde (L) können Muttern M4 eingesetzt werden.
- FR** 6-2 Dans les gorges (L) il est possible d'introduire des écrous M4.
- ES** 6-2 En las ranuras (L) es posible introducir tuercas M4.

6-3)

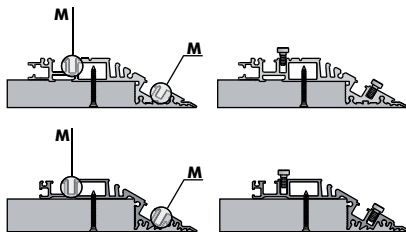

**6.3 IT** 6-3 Nelle gole filettate (M) è possibile avvitare viti M4

**GB** 6-3 M4 screws may be screwed up into the threaded grooves (M). products.

**DE** 6-3 In die Gewinde (M) können Muttern M4 eingesetzt werden.

**FR** 6-3 Dans les gorges filetées (M) il est possible de visser des vis M4.

**ES** 6-3 En las ranuras (M) es posible enroscar tornillos M4.

6-4)

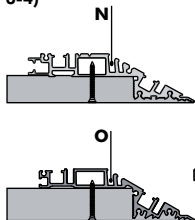

**6.4 IT** 6-4 Nella scanalatura (N) è possibile inserire una lastra di plexiglass di 3mm.

**GB** 6-4 A 3mm-thick plexiglass plate may be inserted in the groove (N).

**DE** 6-4 In die Nut (N) kann eine Plexiglas-Platte der Stärke 3 mm eingesetzt werden.

**FR** 6-4 Dans la rainure (N) il est possible d'introduire une plaque de plexiglass de 3mm d'épaisseur.

**ES** 6-4 En la ranura (N) es posible introducir una placa de plexiglas de 3 mm.

6-5)

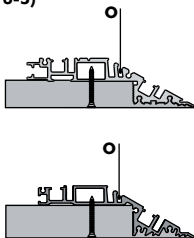

6.5

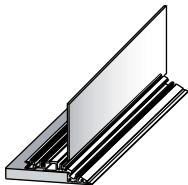

**IT** 6-5 Nella scanalatura (O) è possibile inserire una lastra di plexiglass di 2mm.

**GB** 6-5 A 2mm-thick plexiglas plate may be inserted in the groove (O).

**DE** 6-5 In die Nut (O) kann eine Plexiglas-Platte der Stärke 2 mm eingesetzt werden.

**FR** 6-5 Dans la rainure (O) il est possible d'introduire une plaque de plexiglass de 2mm.

**ES** 6-5 En la ranura (O) es posible introducir una placa de plexiglás de 2 mm.

6-6)

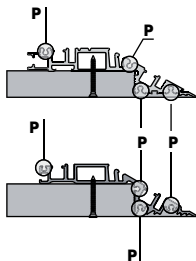

6.6

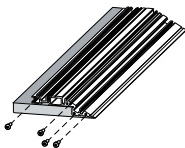

**IT** 6-6 Nei fori (P) è possibile avvitare viti automaschianti M3x10 in senso longitudinale.

**GB** 6-6 Self-tapping screws M3x10 length may be screwed up into the holes (P).

**DE** 6-6 Dans les trous (P) il est possible de visser des vis autotaraudeuses M3x10 dans le sens de la longueur.

**FR** 6-6 In die Löcher (P) können selbst-schneidende Schrauben M3x10 in Längsrichtung eingesetzt werden.

**ES** 6-6 En los orificios (P) es posible enroscar tornillos autorroscantes M3x10 en sentido longitudinal.

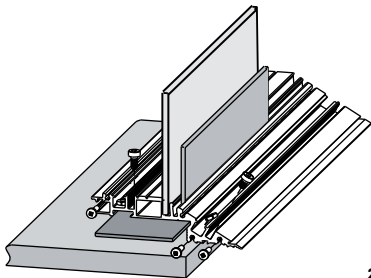

- IT** Con il sistema 094 è possibile realizzare svariate combinazioni di montaggio a seconda delle esigenze. Ora verranno riportati alcuni esempi:
- GB** With sistema 094 a number of assembly combinations can be achieved according to your requirements. A few examples are given below:
- DE** Mit dem sistema 094 können je nach Anforderung verschiedene Montage-Kombinationen verwendet werden. Hier sind einige Beispiele aufgeführt:
- FR** Avec le sistema 094 il est possible de réaliser diverses combinaisons de montage selon les exigences. Voici quelques exemples :
- ES** Con el sistema 094 es posible realizar muchas combinaciones de montaje según las necesidades. A continuación se detallan algunos ejemplos:

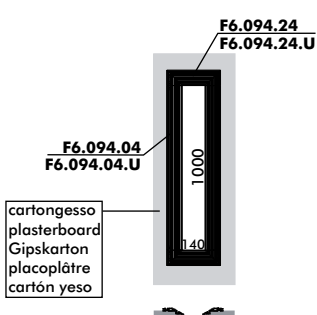

- 1. IT** Taglio 140x1000 utilizzando;  
**F6.094.24** n1 coppia testata 140 ;  
**F6.094.04** n1 coppia profili 1000
- GB** 140x1000 cut by using;  
**F6.094.24** n1 pair of ends 140 ;  
**F6.094.04** n1 profile couple 1000
- DE** Schnitt 140x1000, mit Verwendung von  
**F6.094.24** 1 1 Paar Endstücke 140  
**F6.094.04** 1 1 Paar Profile 1000
- FR** Coupe 140x1000 en utilisant;  
**F6.094.24** 1 paire de finition 140 ;  
**F6.094.04** 1 paire de profils 1000
- ES** Corte 140X1000 utilizando;  
**F6.094.24** n1 pareja cabezal 140 ;  
**F6.094.04** n1 pareja perfiles 1000

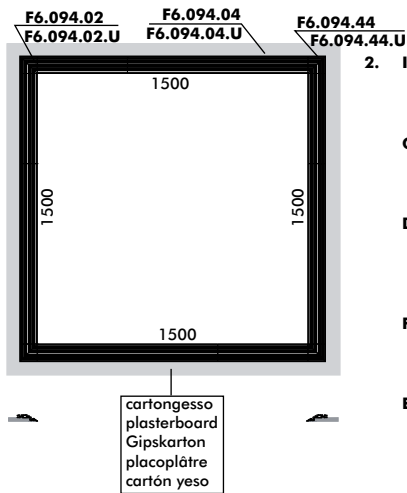

2. **IT** Taglio 1500x1500 combinando;  
**F6.094.02** n2 coppie profili 500;  
**F6.094.04** n2 coppie profili 1000;  
**F6.094.44** n4 raccordi angolari esterni
- GB** 1500x1500 cut by combining;  
**F6.094.02** n2 profile pairs 500;  
**F6.094.04** n2 profile pairs 1000;  
**F6.094.44** n4 external corner join
- DE** Schnitt 1500x1500 mit Kombination von;  
**F6.094.02** n2 Paar Profile 500;  
**F6.094.04** n2 Paar Profile 1000;  
**F6.094.44** n4 einzelne Eckanschlüsse innen
- FR** Coupe 1500x1500 en combinant ;  
**F6.094.02** n2 paires de profils 500;  
**F6.094.02** n2 paires de profils 1000;  
**F6.094.44** n4 un angle extérieur
- ES** Corte 1500x1500 combinando;  
**F6.094.02** n2 parejas perfiles 500;  
**F6.094.04** n2 pareja perfiles 1000;  
**F6.094.44** n4 conexiones angulares exteriores



- 3. IT** Realizzazione di gole chiuse utilizzando una cornice (A) formata da:  
**F6.094.02** n2 coppie profili 500;  
**F6.094.04** n2 coppie profili 1000;  
**F6.094.44** n4 raccordi angolari esterni e una cornice (B) formata da:  
**F6.094.04** n2 coppie profili 1000;  
**F6.094.42** n4 raccordi angolari interni
- GB** Exemple of a double profile forming an outer frame (A) consisting of:  
**F6.094.02** n2 pair of profiles 500;  
**F6.094.04** n2 pair of profiles 1000;  
**F6.094.44** n4 external corner join and an internally filled frame (B) consisting of:  
**F6.094.04** n2 pair of profiles 1000;  
**F6.094.42** n4 internal corner join

- DE** Herstellung von Einlass-Rillen durch Verwendung eines Rahmens (A) bestehend aus:  
**F6.094.02** n2 Paar Profile 500;  
**F6.094.04** n2 Paar Profile 1000;  
**F6.094.44** n4 einzelne Eckanschlüsse außen :und einem Rahmen(B) bestehend aus:  
**F6.094.04** n2 Paar Profile 1000;  
**F6.094.42** n4 einzelne Eckanschlüsse innen

- FR** Réalisation de gorges fermées en utilisant un cadre (A) formé de:  
**F6.094.02** n2 paires de profils 500;  
**F6.094.04** n2 paires de profils 1000;  
**F6.094.44** n4 angles extérieur et un cadre (B) formé de;  
**F6.094.04** n2 paires de profils 1000;  
**F6.094.42** n4 angle intérieur

- ES** Realización de ranuras cerradas utilizando un marco (A) integrado por:  
**F6.094.02** n2 pareja perfiles 500;  
**F6.094.04** n2 pareja perfiles 1000;  
**F6.094.44** n4 conexiones angulares exteriores y un marco (B) integrado por:  
**F6.094.04** n2 pareja perfiles 1000;  
**F6.094.42** n4 conexione angulare interiore

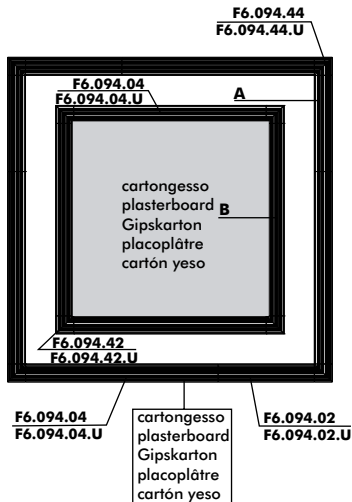

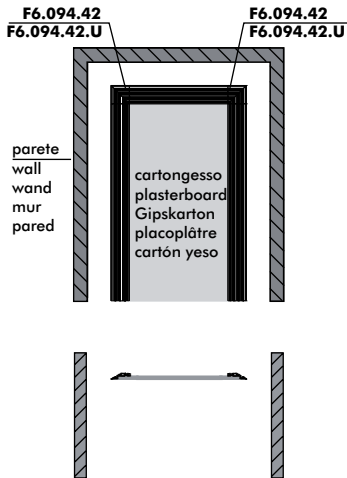

4. **IT** Realizzazione di gole a ridosso della parete utilizzando raccordi angolari interni (F6.094.42-F6.094.42.U)
- GB** Example of a single profile frame next to the wall using internal corner joint (F6.094.42-F6.094.42.U)
- DE** Herstellung von Rillen an der Wand mit Verwendung von Eckanschlüssen innen (F6.094.42-F6.094.42.U)
- FR** Réalisation de gorges parallèle au mur/plafond en utilisant des angles intérieur (F6.094.42-F6.094.42.U)
- ES** Realización de ranuras cerca de la pared utilizando conexión angular interior (F6.094.42-F6.094.42.U)

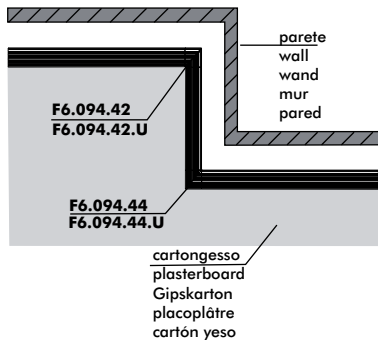

5. **IT** Combinazione di raccordi angolari esterni (F6.094.42-F6.094.42.U) e interni (F6.094.44-F6.094.44.U) potendo così seguire l'andamento della parete.
- GB** Example of the both external corner joints (F6.094.42-F6.094.42.U) and internal corner joints (F6.094.44-F6.094.44.U), follow the contour of the wall.
- DE** Die Kombination aus Eckanschlüssen außen (F6.094.42-F6.094.42.U) und Eckanschlüssen innen (F6.094.44-F6.094.44.U) ermöglicht es, sich der Wandkontur anzupassen.
- FR** Combinaison de raccords angulaires externes (F6.094.42-F6.094.42.U) et intérieurs (F6.094.44-F6.094.44.U) pour suivre le mur.
- ES** Combinación de conexiones angulares exteriores (F6.094.42-F6.094.42.U) e interiores (F6.094.44-F6.094.44.U), pudiendo así seguir la marcha de la pared. 26

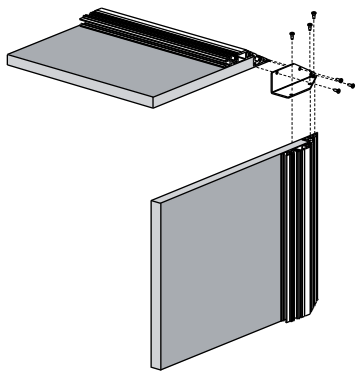

- 6**
- IT** Combinazione di raccordi angolari verticale/orizzontale (**F6.094.45**) potendo così seguire l'andamento della parete.
  - GB** Combination of vertical/horizontal angle joints (**F6.094.45**), to adapt to the shape of the wall.
  - DE** Kombination aus senkrechten/waagerechten Eckanschlüssen (**F6.094.45**), was ermöglicht, sich dem Wandverlauf anzupassen.
  - FR** combinaison de raccords angulaires vertical/horizontal (**F6.094.45**) pour suivre la paroi.
  - ES** Combinación de conexiones angulares vertical/horizontal (**F6.094.45**), pudiendo así seguir la marcha de la pared.

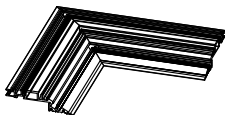
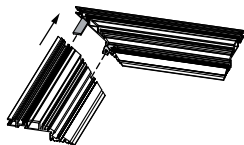
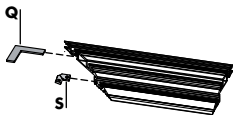
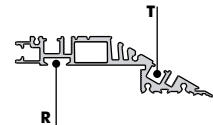

- 7. IT** se si decide di creare angoli 90° senza utilizzare i raccordi preassemblati **(F6.094.42-F6.094.44 europa) o (F6.094.42.U-F6.094.44.U u.s.a)**, occorre utilizzare la coppia di giunti angolari **(F6.094.48)** per unire i profili 094. inserire il giunto (Q) nella gola (R) del profilo e il giunto (S) nella gola (T) fino a che i due giunti non vanno in battuta con il profilo.

inserire il secondo profilo sui giunti e serrare i grani presenti sui giunti (S) per fissare i profili tra di loro.

- GB** if it is decided to create 90° angles without using the pre-assembled connector **(F6.094.42-F6.094.44 europa) or (F6.094.42.U-F6.094.44.U u.s.a)**, the pair of angle joints **(F6.094.48)** should be used to connect the 094 profiles.

put joint (Q) into throat (R) of the profile and joint (S) into throat (T), until the two joints butt up against the profile.

put the second profile onto the joints and tighten the grub screws on the joints (S) to fix the profiles together.

- DE** Wenn man 90°-Winkel schaffen will, ohne die vormontierten Anschlüsse **(F6.094.42-F6.094.44 Europa)** oder **(F6.094.42.U-F6.094.44.U USA)** zu benutzen, müssen die beiden Winkelverbinder **(F6.094.48)** benutzt werden, um die Profile 094 zu vereinen.

Den Verbinder (Q) in die Rille (R) des Profils und den Verbinder (S) in die Rille (T) einsetzen, bis die beiden Verbinder am Profil anstoßen.

Das zweite Profil auf die Verbinder setzen und die Stifte an den Verbindern (S) anziehen, um die Profile miteinander zu verbinden

- FR** pour créer des angles à 90° sans utiliser les raccords pré-assemblés (**F6.094.42-F6.094.44 europe**) ou (**F6.094.42.U-F6.094.44.U u.s.a**), il est nécessaire d'utiliser la paire de joints d'angle (**F6.094.48**) pour unir les profils 094. introduire le joint (Q) dans la gorge (R) du profil et le joint (S) dans la gorge (T) jusqu'à ce que ces deux joints soient en butée contre le profil. mettre en place le second profil sur les joints et serrer les pions présents sur les joints (S) pour fixer les profils l'un à l'autre
- ES** si se decide crear ángulos de 90° sin utilizar los empalmes pre-ensamblados (**F6.094.42-F6.094.44 europa**) o (**F6.094.42.U-F6.094.44.U u.s.a**), hay que utilizar el par de juntas angulares (**F6.094.48**) para unir los perfiles 094. introducir la junta (Q) en el canal (R) del perfil y la junta (S) en el canal (T) hasta que las dos juntas hagan tope con el perfil. introducir el segundo perfil en las juntas y apretar las espigas de las juntas (S) para fijar los perfiles entre sí.

Viabizzuno strada principale della frazione Bizzuno in provincia di Ravenna dove tra la casa del popolo e la parrocchia, al n°17, sono nato il ventuno luglio millenovecentocinquantacinque.

mn

**Viabizzuno** raccoglie attorno a sé esperienza, conoscenza e ricerca per poter meglio esprimere il proprio 'modo di fare luce'. il pensiero progettuale di Viabizzuno si identifica in una pagina bianca. due linee di prodotti complementari occupano questo spazio esplorandolo, dilatandolo: si incrociano forti della propria identità, due anime rappresentate dalle collezioni For m e Alvaline. inoltre sviluppa e realizza apparecchi di illuminazione speciali e su misura. è fondamentale che il progetto sia stimolante e che l' interlocutore sia preparato a una progettazione complessa, che richiede tempo e impegno. progettiamo la luce a 360°.

Viabizzuno is the name of the main road in the small village of Bizzuno in the province of Ravenna, where I was born on the 21st of July 1955 at No.17, between the "casa del popolo" (house of the people) and the local parish church.

mn

**Viabizzuno** musters experience, knowledge and research to express its "way of making light" in the best way possible. Viabizzuno's design philosophy corresponds to a blank page and two complementary product lines fill the space, exploring and expanding it; like kindred spirits, the For m and Alvaline collections interlock, confident in their own identity. Viabizzuno also designs and produces special and custom-made lighting equipment. it is essential that the project should be stimulating and that the other party is prepared for a complex design process, requiring time and commitment. we design light at 360°.



***energia pulita***  
***clean energy***



**For m** divide lo spazio verticalmente: equilibrata, razionale, rigorosa.

il corpo illuminante evolve nella sua funzione di fare luce:

il suo uso é sempre più flessibile e la sua capacità di fondersi con l'architettura ne fa un vero materiale da costruzione, attraverso un design non invasivo, non mimetico, non sfacciatamente decorativo.

i corpi illuminanti si ritraggono nelle pareti, a filo intonaco, a scomparsa, nascosti alla vista lasciando piena soggettività alla luce. il grigio dei materiali come cemento, alluminio, acciaio é il colore della collezione For m.

**For m** divides space vertically; it is balanced, rational and rigorous.

the light fitting is evolving in the way it produces light:

it is increasingly flexible and its ability to blend in with the architecture makes it a genuine building material, due to its non intrusive, non imitative design, which is not ostentatiously ornamental.

the light fittings recede into the walls, flush with the plaster, concealed, hidden from view and leaving the whole scene to the light. the colour of the For m collection is grey, like the materials of cement, aluminium and steel.



manuale For m 2007  
manual For m 2007



italiano  
cod.19091



english  
français  
русский язык  
cod.19092



english  
español  
deutsch  
cod.19093

cartella colori e finiture  
folder sample finishes  
and colours



cod. 19941

libro For m  
book For m

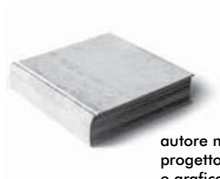

autore mario nanni  
progetto editoriale  
e grafico Viabizzuno  
edito da Viabizzunoeditore  
seconda edizione  
author mario nanni  
Viabizzuno publishing  
and graphics project edited  
by Viabizzunoeditore  
second edition  
cod. 15248

**Alvaline** attraversa lo spazio diagonalmente: dinamica, irriverente, ironica, giocosa. inizia il gesto, dove si muovono gli sguardi, dove la materia si fonde mescolandosi alla luce, si originano così colore e forma, che vivono per se stesse e per l'emozione che li circonda. il blu della notte é il suo colore.

**Alvaline** cuts through space diagonally; it is dynamic, irreverent, witty and playful. it makes the first move, marked by shifting glances and matter blending with the light, so colour and form are created, living a life of their own and of the emotion that surrounds them. its colour is midnight blue.



italiano  
cod.16162-2



english  
français  
русский язык  
cod.16164-2



english  
español  
deutsch  
cod.16166-2

cartella colori e finiture  
folder sample finishes  
and colours



cod. 19941



vol.1 **E27**  
cod.00285



vol.2 **h2o**  
cod.00283



vol.3 **bamboo**  
cod.00289



vol.4 **alva1**  
cod.00291



vol.5 **clv1**  
cod.00286



vol.6 **biblio**  
cod.00288



vol.7 **mon amour**  
cod.00282



vol.8 **emma**  
cod.00287



vol.9 **clv2**  
cod.00284



vol.10 **tulp**  
cod.00290



vol.11 **fileau**  
cod.14564



vol.13 **UpOGalleggio**  
cod.15215



vol.14 **steelon**  
cod.17904



vol.18 **toccamì**  
cod.17777



vol.19 **la DOdò**  
cod.17779



vol.20 **plag in**  
cod.17778

**Viabizzuno** srl

10 via ramagnoli  
40010 bentivoglio  
bologna italia

t+39 0518908011  
f+390518908089

[www.viabizzuno.com](http://www.viabizzuno.com)

[viabizzuno@viabizzuno.com](mailto:viabizzuno@viabizzuno.com)