

# Profilul DES

Ref. A18030

Ref. arch 18030

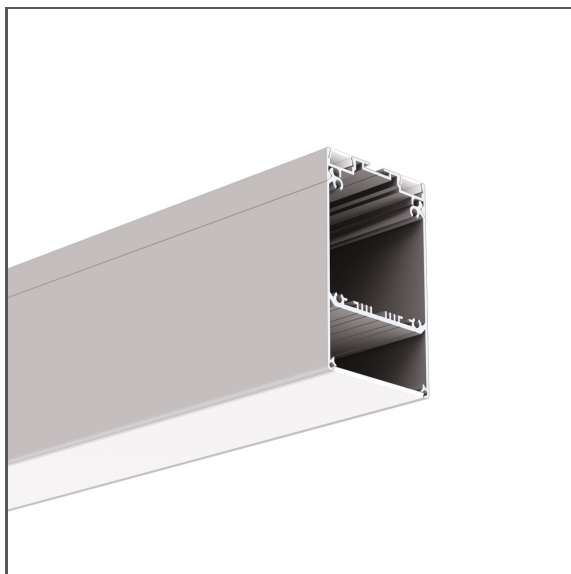

- Două direcții ușoare
- Posibilitatea de a obține UGR < 19
- Spațiu pentru unități de alimentare cu energie și componente electronice
- Servisare ușoară
- Gamă largă de accesorii

## ACTIVELE DE PRODUS

- iluminat principal și decorativ

## MONTAJ

- suspendat, folosind o bandă de montare dedicată și accesorii dedicate
- posibilitatea de a fi combinate cu ușurință în șiruri și sisteme

## ADDITIONAL INFORMATION

- posibilitatea de blocare a sursei de alimentare în interiorul profilului folosind accesorii dedicate
- lungimi standard de profile și capace Kluš: 1000mm (toleranță ± 1,5 mm) și 2005mm / 3010mm (toleranță +5mm); pentru capacele selectate 6050mm, 10050mm (toleranță +5mm)
- În cazul în care alegeți o altă lungime a profilelor / capacele decât cea disponibilă ca standard, trebuie să alegeți în plus serviciul de tăiere de la firma KLUŠ

## DESEN TEHNIC

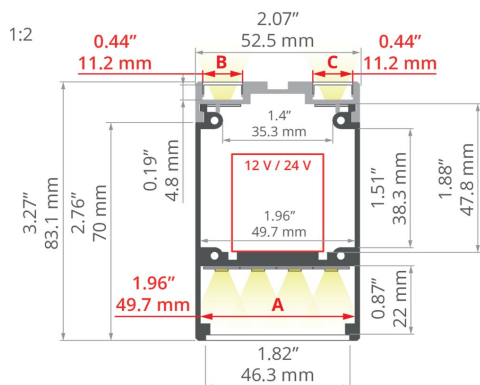

## SPECIFICAȚII TEHNICE

Material	aluminiu
IP posibil de fixare	20
Forme posibile de fixare	dreptunghiular
Secțiune transversală profil	dreptunghiular
Lățime	52.5 mm
Înălțime	83.1 mm
Lățimea lipire LED A	49.7 mm
Lățimea lipire LED B	11.2 mm
Lățimea lipire LED B	11.2 mm
Numărul de benzi LED A (8 mm lățime)	6
Numărul de benzi LED B (8 mm lățime)	1
Numărul de benzi LED C (8 mm lățime)	1
Cu compartiment pentru sursa de alimentare	da
Cu posibilitate obținerii liniei de lumină	da
Tipul clădirii	Commercial, Retail
Zona de facilitati	office, lobby / foyer
Capacul este tăiat la lungimea profilului	da
Pot fi înșirate cu ușurință	da

Culoare	Lungime	Ref
■ argint anodizat	1000 mm	A18030A_1 18030ANODA_1
	2005 mm	A18030A_2 18030ANODA_2
	3010 mm	A18030A_3 18030ANODA_3
■ negru anodizat	1000 mm	A18030A07_1 18030K7_1
	2005 mm	A18030A07_2 18030K7_2
	3010 mm	A18030A07_3 18030K7_3

# Profilul DES

Ref. A18030





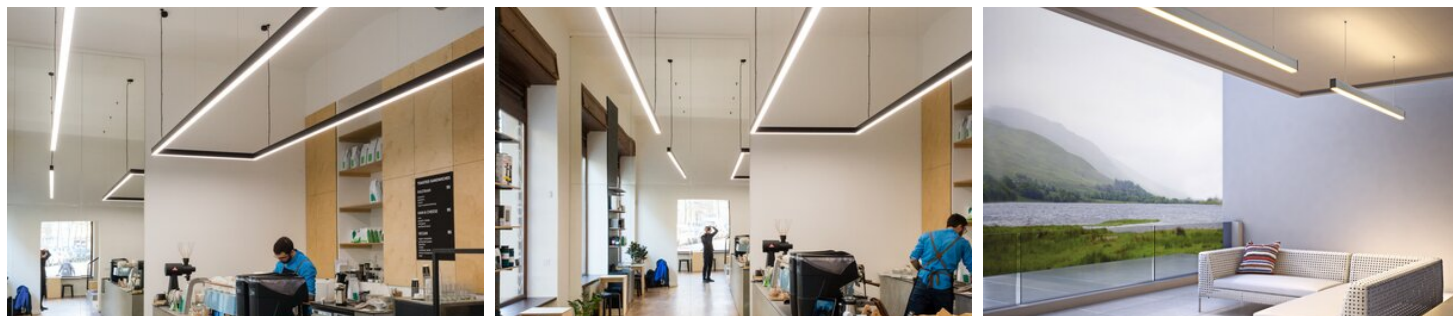

Ref. arch 18030

leșire a cablului pe dedesubt	da
iluminat reversibil pentru corpurile de iluminat suspendate	da

## SAMPLE PROJECTS



## ACCESORII AFERENTE > DIFUZOR

NUME	MATERIAL	TRASMITANȚA	CULOARE	REF.	
KA		PC	63 %	<input type="checkbox"/> mate	B17035M 17035
			91 %	<input checked="" type="checkbox"/> transparente	B17035T 17036
KA-PRO		PC	67 %	<input type="checkbox"/> mate	B17064M 17064
			94 %	<input checked="" type="checkbox"/> transparente	B17064T 17065
DHS		PC	73 %	<input type="checkbox"/> mate	B17052M 17052
			94 %	<input checked="" type="checkbox"/> transparente	B17052T 17063
HS		PC	73 %	<input type="checkbox"/> mate	B17208M 1369
			94 %	<input checked="" type="checkbox"/> transparente	B17208T 1370
KA-COM		PVC	70 %	<input type="checkbox"/> mate	B17179M 17179
			93 %	<input checked="" type="checkbox"/> transparente	B17179T 17180
LIGER		PC	70 %	<input type="checkbox"/> mate	B17037M 17037
			32 %	<input checked="" type="checkbox"/> negru	B17037C 17040
JUN-47		PMMA	92 %	<input checked="" type="checkbox"/> transparente	B17059P 17059

### ACCESORII AFERENTE > CAPACE DE CAPĂT

NUME	MATERIAL	CULOARE	REF.
DESIN	PP	argint	C24151L01 24151
		negru	C24151C02 24348
DES	oțel inoxidabil	oțel	C28209A01 42616
DES-HQ	aluminiu	gri	C28218AS 42626

### ACCESORII AFERENTE > RELATED LED

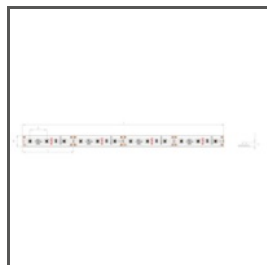

**K-1210-12V**  
K-1210-12  
Ref. arch K-1210-12V



**K-1275-12V**  
K-1275-12  
Ref. arch K-1275-12V



**WP-K-1220-12V**  
KWP-1220-12  
Ref. arch WP-K-1220-12V

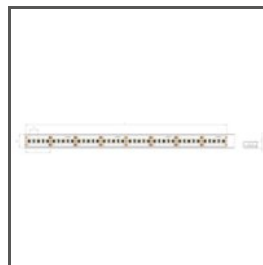

**WP-K-1275-12V**  
KWP-1275-12  
Ref. arch WP-K-1275-12V



**WP-K-1220-IP65-12V**  
\_bład  
Ref. arch WP-K-1220-IP65-12V

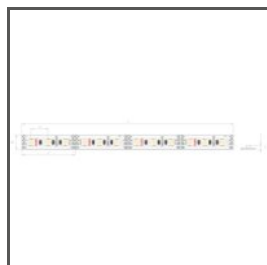

**K-1275-RGB-12V**  
K-RGB-1275-12  
Ref. arch K-1275-RGB-12V

### ACCESORII AFERENTE > RELATED LED > ALB MONO



**WP-K-1640-HD-IP65-24V**  
KWP-GHD-1640-24  
Ref. arch WP-K-1640-HD-IP65-24V



**WP-K-1910-HD-IP65-24V**  
KWP-GHD-1910-24  
Ref. arch WP-K-1910HDIP6524V



**WP-K-1220-IP65-24V**  
KWP-1220-IP65-24  
Ref. arch WP-K-1220-IP65-24V

### ACCESORII AFERENTE > RELATED LED > RGB / RGB-W / RGB-CTT

# Profilul DES

Ref. A18030

Ref. arch 18030



**K-1530-RGB+W-24V**  
K-RGBW-1530-24  
Ref. arch K-1530-RGB+W-24V



**WP-K-1530-RGB+W-24V**  
KWP-RGBW-1530-24  
Ref. arch WP-K-1530-RGB+W-24V

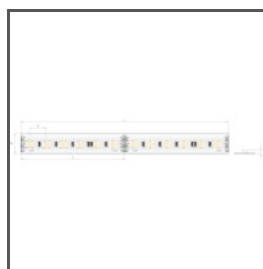

**K-1920-120-RGB-24V**  
K-RGB-1920-120-24  
Ref. arch K-1920-120-RGB-24V

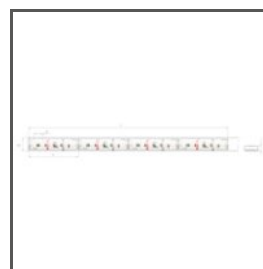

**WP-K-1920-120-RGB-24V**  
KWP-1920-120-RGB-24  
Ref. arch WP-K-1920-120-RGB-24V

## ACCESORII AFERENTE > RELATED LED > RANDAMENT LUMINOS RIDICAT

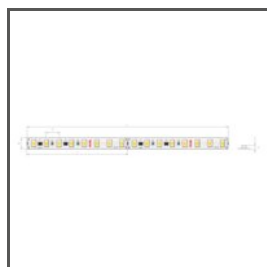

**K-HE-0480-HD-24V**  
K-HEHD-0480-24  
Ref. arch K-HE-0480-HD-24V

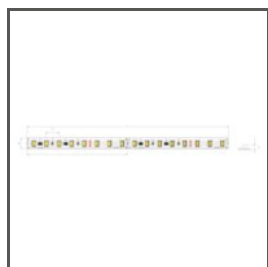

**K-HE-0960-HD-24V**  
K-HEHD-0960-24  
Ref. arch K-HE-0960-HD-24V

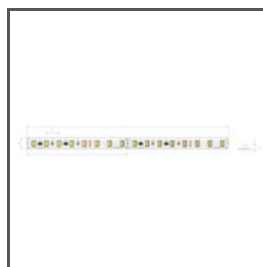

**K-HE-1440-HD-24V**  
K-HEHD-1440-24  
Ref. arch K-HE-1440-HD-24V

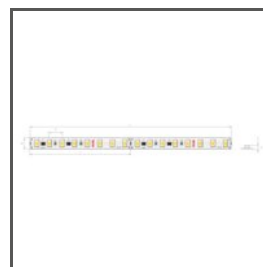

**K-HE-1920-HD-24V**  
K-HEHD-1920-24  
Ref. arch K-HE-1920-HD-24V

## ACCESORII AFERENTE > ARTICOLE SUPLIMENTARE > ALTE ACCESORII

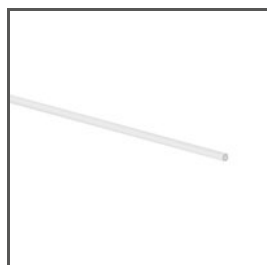

TIJĂ DIN PLASTIC

**DES**

\_bląd

Ref. arch 42222

## ACCESORII AFERENTE > ARTICOLE SUPLIMENTARE > ALTELE



PRESETUPĂ  
**6x1,2**  
C24517C07  
Ref. arch 00802



PRESETUPĂ  
**M8x1**  
C42265N00  
Ref. arch 42265

ACCESORII AFERENTE > ARTICOLE SUPLIMENTARE > CONECTORI



CONECTOR  
**ZM-NA-120**  
C28242N00  
Ref. arch 42729

ACCESORII AFERENTE > ARTICOLE SUPLIMENTARE > DISPOZITIVE DE SIGURANȚĂ ȘI DE BLOCARE



BLOCADĂ  
**ZD**  
C28195N00  
Ref. arch 42521

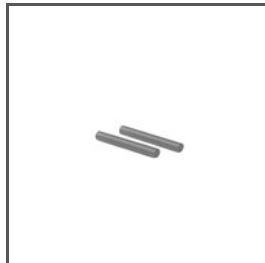

BLOCADĂ  
**ZM**  
C28194N00  
Ref. arch 42520

ACCESORII AFERENTE > ARTICOLE SUPLIMENTARE > INSERȚII TEHNICE ȘI DE PROTECȚIE



PLACĂ DE MONTARE  
**45**  
Z70457  
Ref. arch 70457

ACCESORII AFERENTE > ARTICOLE SUPLIMENTARE > SETURI DE SUSPENSIE ȘI DE FIXARE

# Profilul DES

Ref. A18030

Ref. arch 18030



SET MONTAJ

**RG-1**

C28230P00, C28230P01,  
C28230L10, C28230L07  
Ref. arch 42647NI, 42647GSS,  
42647L9010, 42647L9005

---

ACCESORII AFERENTE > ARTICOLE SUPLIMENTARE > SUPORTURI DE SUSPENDARE ȘI CAPACE PENTRU PROFIL CONDUCTOR



DISPOZITIV DE FIXARE

**PUSZ-LIN-ZD**

C28164N00, C28164L10,  
C28164L07  
Ref. arch 42279, 42279L9010,  
42279L9005



DISPOZITIV DE FIXARE

**PUSZ-PRET-ZD**

C28167N00, C28167L10,  
C28167L07  
Ref. arch 42282, 42282L9010,  
42282L9005

---

ACCESORII AFERENTE > ARTICOLE SUPLIMENTARE > SUPORTURI DE SUSPENDARE ȘI CAPACE PENTRU PROFIL STANDARD



CAP

**BZP**

C28113N00  
Ref. arch 42213



DISPOZITIV DE FIXARE

**UCHO-ZD**

C28193N00  
Ref. arch 42513

---

ACCESORII AFERENTE > ARTICOLE SUPLIMENTARE > SUPORTURI DE SUSPENDARE ȘI DE FIXARE A CONDUCTORULUI

# Profilul DES

Ref. A18030

Ref. arch 18030



DISPOZITIV DE FIXARE

**W-BOX-Z**

C28253N00

Ref. arch 00643