

Profilul TRIADA

Ref. A04476

Ref. arch B4476

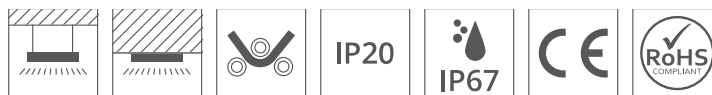
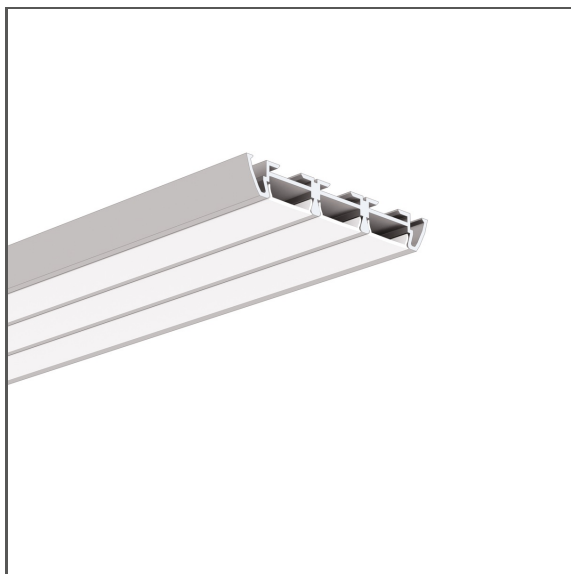

- Randament iluminare ridicat
- Pereți netezi ai profilului
- Gamă largă de accesorii
- Rază mică de îndoire

ACTIVELE DE PRODUS

- iluminat principal și funcțional

MONTAJ

- suspendat sau la suprafață, cu ajutorul unei benzi de montaj dedicată, accesorii dedicate sau șuruburi selectate corespunzător
- posibilitatea de a fi combinate cu ușurință în șiruri și sisteme

ADDITIONAL INFORMATION

- lungimi standard de profile și capace Kluś: 1000mm (toleranță ± 1,5 mm) și 2005mm / 3010mm (toleranță +5mm); pentru capacele selectate 6050mm, 10050mm (toleranță +5mm)
- În cazul în care alegeți o altă lungime a profilelor / capacelelor decât cea disponibilă ca standard, trebuie să alegeți în plus serviciul de tăiere de la firma KLUŚ

DESEN TEHNIC

1:2

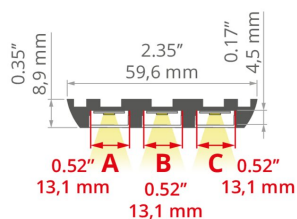

SPECIFICAȚII TEHNICE

Material	aluminiu
Culoare	argint anodizat
IP posibil de fixare	20, 67
Forme posibile de fixare	poligonal
Secțiune transversală profil	dreptunghiular
Lățime	59.6 mm
Înălțime	8.9 mm
Lățimea lipire LED A	13.1 mm
Lățimea lipire LED B	13.1 mm
Lățimea lipire LED B	13.1 mm
Numărul de benzi LED A (8 mm lățime)	1
Numărul de benzi LED B (8 mm lățime)	1
Numărul de benzi LED C (8 mm lățime)	1
Poate fi îndoit	da
Raza exterioară minimă	200 mm
Raza internă minimă	200 mm
Tipul clădirii	Commercial, Retail, Entertainment/ Arts

Lungime	Ref
1000 mm	A04476A_1 B4476ANODA_1
2005 mm	A04476A_2 B4476ANODA_2
3010 mm	A04476A_3 B4476ANODA_3

Profilul TRIADA

Ref. A04476

Ref. arch B4476

Zona de facilitati	industrial and technical, shop windows and exhibition
Capacul este tăiat la lungimea profilului	da
Pot fi înșirate cu ușurință	da
Ieșire a cablului pe dedesubt	da

SAMPLE PROJECTS

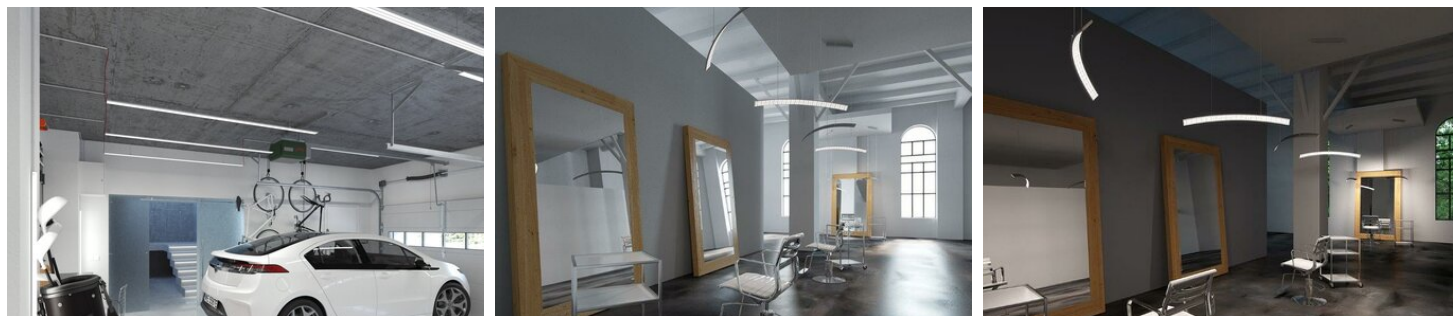

PROFILURI CONEXE > PROFILURI TEHNICE

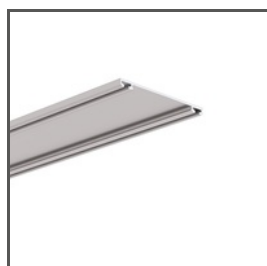



TETRA-43
A04478
Ref. arch W4476



TETRA-78
A04508
Ref. arch W4508

ACCESORII AFERENTE > DIFUZOR

NUME	MATERIAL	TRASMITANȚA	CULOARE	REF.
KA-PRO-12		74 %	<input type="checkbox"/> mate	B17066M 17066
		94 %	<input checked="" type="checkbox"/> transparente	B17066T 17067
KA-12		69 %	<input type="checkbox"/> mate	B17078M 17078
		94 %	<input checked="" type="checkbox"/> transparente	B17078T 17079
HS-12		73 %	<input type="checkbox"/> mate	B17201M 00157
		94 %	<input checked="" type="checkbox"/> transparente	B17201T 00158

Profilul TRIADA

Ref. A04476

Ref. arch B4476

ACCESORII AFERENTE > CAPACE DE CAPĂT

NUME	MATERIAL	CULOARE	REF.
TRIADA		gri	C24056C02 00090
		argint	C24056L01 24056

ACCESORII AFERENTE > RELATED LED

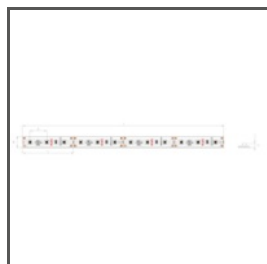

K-1210-12V
K-1210-12
Ref. arch K-1210-12V



K-1275-12V
K-1275-12
Ref. arch K-1275-12V



WP-K-1220-12V
KWP-1220-12
Ref. arch WP-K-1220-12V

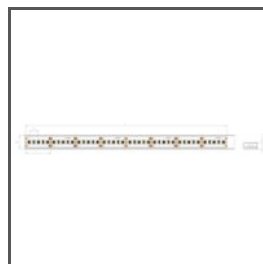

WP-K-1275-12V
KWP-1275-12
Ref. arch WP-K-1275-12V



WP-K-1220-IP65-12V
_bład
Ref. arch WP-K-1220-IP65-12V

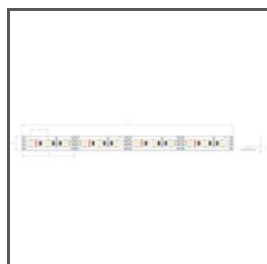

K-1275-RGB-12V
K-RGB-1275-12
Ref. arch K-1275-RGB-12V

ACCESORII AFERENTE > RELATED LED > ALB MONO



WP-K-1910-HD-IP65-24V
KWP-GHD-1910-24
Ref. arch WP-K-1910HDIP6524V

ACCESORII AFERENTE > RELATED LED > CRI 95+



WP-K-CR-1210-24V
KWP-CR-1210-24
Ref. arch WP-K-CR-1210-24V



WP-K-CR-1220-24V
KWP-CR-1220-24
Ref. arch WP-K-CR-1220-24V



WP-K-CR-1275-24V
KWP-CR-1275-24
Ref. arch WP-K-CR-1275-24V

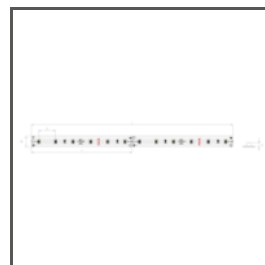

K-CR-1210-24V
K-CR-1210-24
Ref. arch K-CR-1210-24V

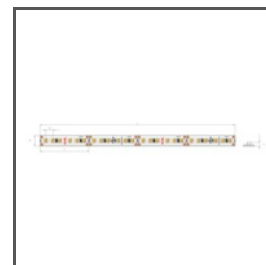

K-CR-1220-24V
K-CR-1220-24
Ref. arch K-CR-1220-24V

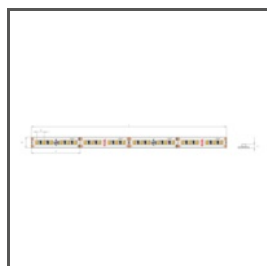

K-CR-1275-24V
K-CR-1275-24
Ref. arch K-CR-1275-24V

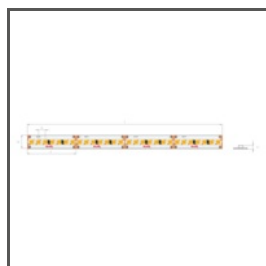

K-CR-1820-HD-24V
K-CRHD-1820-24
Ref. arch K-CR-1820-HD-24V

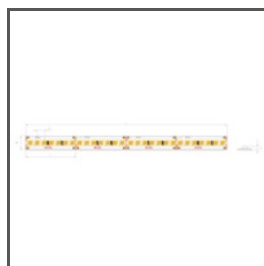

K-CR-1910-HD-24V
K-CRHD-1910-24
Ref. arch K-CR-1910-HD-24V

ACCESORII AFERENTE > RELATED LED > RGB / RGB-W / RGB-CTT



K-1530-RGB+W-24V
K-RGBW-1530-24
Ref. arch K-1530-RGB+W-24V

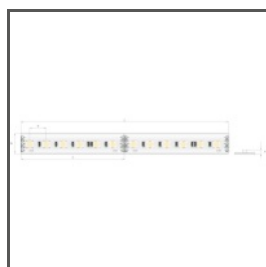

K-1920-120-RGB-24V
K-RGB-1920-120-24
Ref. arch K-1920-120-RGB-24V

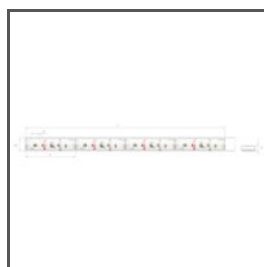

WP-K-1920-120-RGB-24V
KWP-1920-120-RGB-24
Ref. arch WP-K-1920-120-RGB-24V

ACCESORII AFERENTE > RELATED LED > RANDAMENT LUMINOS RIDICAT

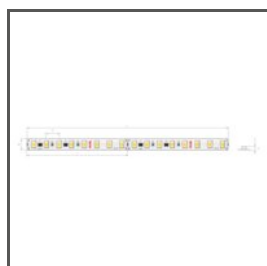

K-HE-0480-HD-24V
K-HEHD-0480-24
Ref. arch K-HE-0480-HD-24V

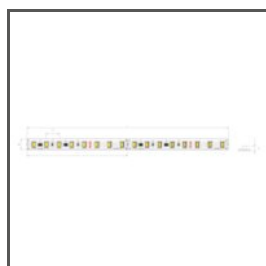

K-HE-0960-HD-24V
K-HEHD-0960-24
Ref. arch K-HE-0960-HD-24V

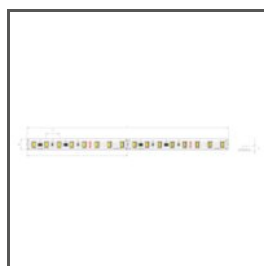

K-HE-1440-HD-24V
K-HEHD-1440-24
Ref. arch K-HE-1440-HD-24V

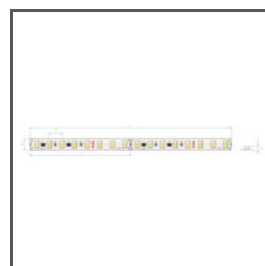

K-HE-1920-HD-24V
K-HEHD-1920-24
Ref. arch K-HE-1920-HD-24V

ACCESORII AFERENTE > ARTICOLE SUPLIMENTARE > ALTELE



PRESETUPĂ

6x1,2

C24517C07

Ref. arch 00802

ACCESORII AFERENTE > ARTICOLE SUPLIMENTARE > ARCURILE MONTATE PE SUPRAFAȚĂ

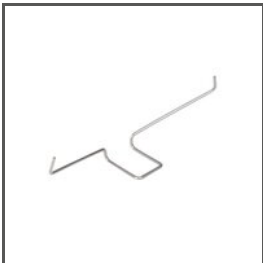

ARC

TR

C24502N00

Ref. arch 00801

ACCESORII AFERENTE > ARTICOLE SUPLIMENTARE > CONECTORI



CONECTOR

ZD-PION-90

C28244N00

Ref. arch 43504



CONECTOR

ZD-PION-135

C28245N00

Ref. arch 43505

ACCESORII AFERENTE > ARTICOLE SUPLIMENTARE > DISPOZITIVE DE SIGURANȚĂ ȘI DE BLOCARE

Profilul TRIADA

Ref. A04476

Ref. arch B4476



BLOCADĂ

ZD

C28195N00

Ref. arch 42521

ACCESORII AFERENTE > ARTICOLE SUPLIMENTARE > SETURI DE SUSPENSIE ȘI DE FIXARE



SET MONTAJ

RG-1

C28230P00, C28230P01,
C28230L10, C28230L07

Ref. arch 42647NI, 42647GSS,
42647L9010, 42647L9005

ACCESORII AFERENTE > ARTICOLE SUPLIMENTARE > SUPORTURI DE SUSPENDARE ȘI CAPACE PENTRU PROFIL CONDUCTOR



DISPOZITIV DE FIXARE

PUSZ-LIN-ZD

C28164N00, C28164L10,
C28164L07

Ref. arch 42279, 42279L9010,
42279L9005



DISPOZITIV DE FIXARE

PUSZ-PRET-ZD

C28167N00, C28167L10,
C28167L07

Ref. arch 42282, 42282L9010,
42282L9005

ACCESORII AFERENTE > ARTICOLE SUPLIMENTARE > SUPORTURI DE SUSPENDARE ȘI CAPACE PENTRU PROFIL STANDARD

Profilul TRIADA

Ref. A04476

Ref. arch B4476

KLUŚ Inspiring
Solutions



DISPOZITIV DE FIXARE

UCHO-ZD

C28193N00

Ref. arch 42513